

# Pickup-arm design techniques

History of the development of pickup arms, with a description of design methods used in a modern arm

by Tejinder Singh Randhawa VU2TSR

THE AUTHOR of this article has recently designed and constructed his own pickup arm based on the experience he gained on an earlier inferior design. The following text does not attempt to describe the constructional details of the new pickup arm, but instead concentrates on the methods employed in its design. In addition to attempting to remove some existing fallacies on the subject of pickup arms, the author has traced the history of their development from the end of the nineteenth century to the present day.

"Mary had a little lamb," history's first recorded phrase, squeaked out from the hill-and-dale recording of the tinfoil-layered cylinder of Edison's phonograph in 1877. The gramophone, which substituted wax for tinfoil, was patented by Chicester Bell and Charles Tainter in 1886. In the following year, the precursor of the modern record player — a gramophone using laterally-recorded discs — was developed by Emile Berliner, and in 1890 the English artist Francis Berraud painted the form of Nipper, quizzically peering into the reproducing horn of a gramophone, listening to "His Master's Voice".

It was to the credit of these older record reproducing machines that the sound box arm, a rough equivalent term to the present day 'pickup arm', was of substantial design and construction. With the introduction of electrical transducers came the early pickup arms of the simple stub type and, over the years, precision pickup arms have developed into the pleasingly intricate and technically perfected designs common today.

## Tracking error

One of the first problems faced by pickup arm designers was tracking error, which is illustrated in Figs 1a and 1b. It was not the resulting distortion which brought the problem to their attention, but the excessive record wear. According to extracts from 1937 issues of the American magazine *Electronics*, it is probable that European and Australian audio firms were the first to benefit from the use of a bent arm to decrease tracking error, as follows: "A survey of the literature indicates that the situation has been thoroughly appreciated abroad. Notable examples of tone arms which correct for tracking

angle can be found in the products of manufacturers in England, Continental Europe and Australia. All of these devices are of the bent arm type<sup>1</sup>." In October 1937, C. J. Lebel wrote<sup>2</sup>, "the only fundamental improvement in pickup arms to appear in a long while is the use of the bent arm. This has been standard practice in England for some time. A consideration of the theory, as given by P. Wilson and G. W. Webb<sup>3</sup>, shows that the reduction of needle tracking error is very great. . . . American manufacturers will undoubtedly change over as their dies wear out." When Lebel wrote this, the Wilson alignment protactor<sup>4</sup> was already being marketed in England by *The Gramophone*. A month later, B. Olney<sup>5</sup> recorded, "For several years past a feature of phonographs produced abroad has been some special arrangement of the pickup arm for minimizing the so-called tracking error, but it is only lately that such devices have made their appearance in this country. In 1930 the author became interested in this

subject through an article published in a British journal *Wireless World*<sup>6</sup>."

At about this time, in America, attention was drawn to the distortion produced by tracking error. In 1941, H. G. Baerwald carried out a rigorous mathematical analysis of tracking error and the resulting distortion<sup>7</sup>, and derived the fundamental equation (Equation 1) relating tracking error distortion to recording variables. In a simpler analysis in 1945, B. Bauer<sup>8</sup> derived the two compact equations (Equations 2 and 3) to determine the optimum offset angle and overhang for a pickup arm. Bauer's equations held their ground until 1966 when J. K. Stevenson<sup>9</sup> derived new formulae, which gave results slightly nearer the optimum than Bauer's formulae because the approximation ( $\sin(X) = X$  Radians for small values of  $X$ ) was not used.

Two years ago the author developed a 'direct' method which, by using a computer iteration method, gave marginally better results than the geometrical analyses employed in 1941, 1945 and 1966. The table shows the results obtained by the author's method. On the whole Stevenson's and the author's analyses give results which are slightly better

The author's record deck showing the turntable and pickup arm.

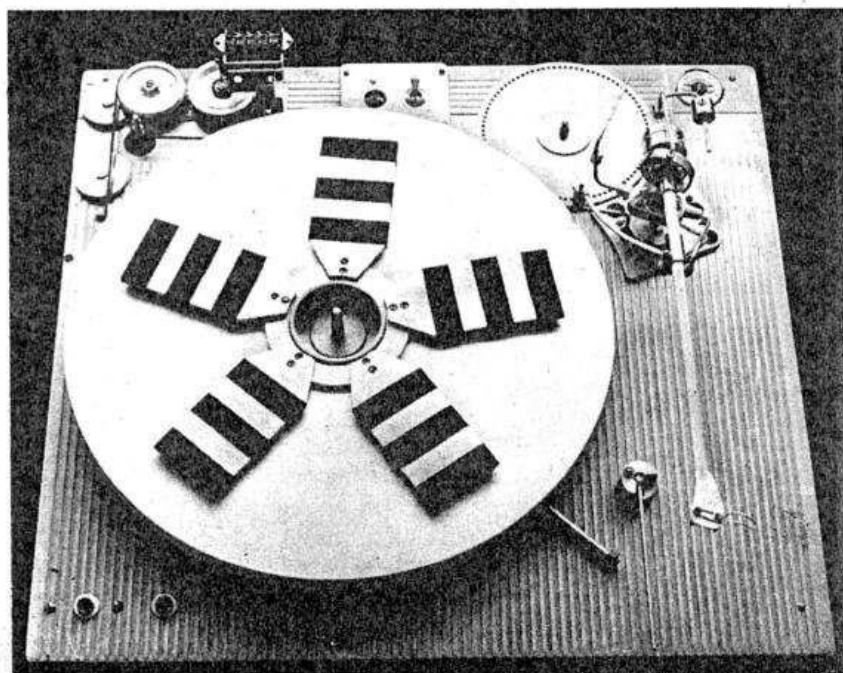

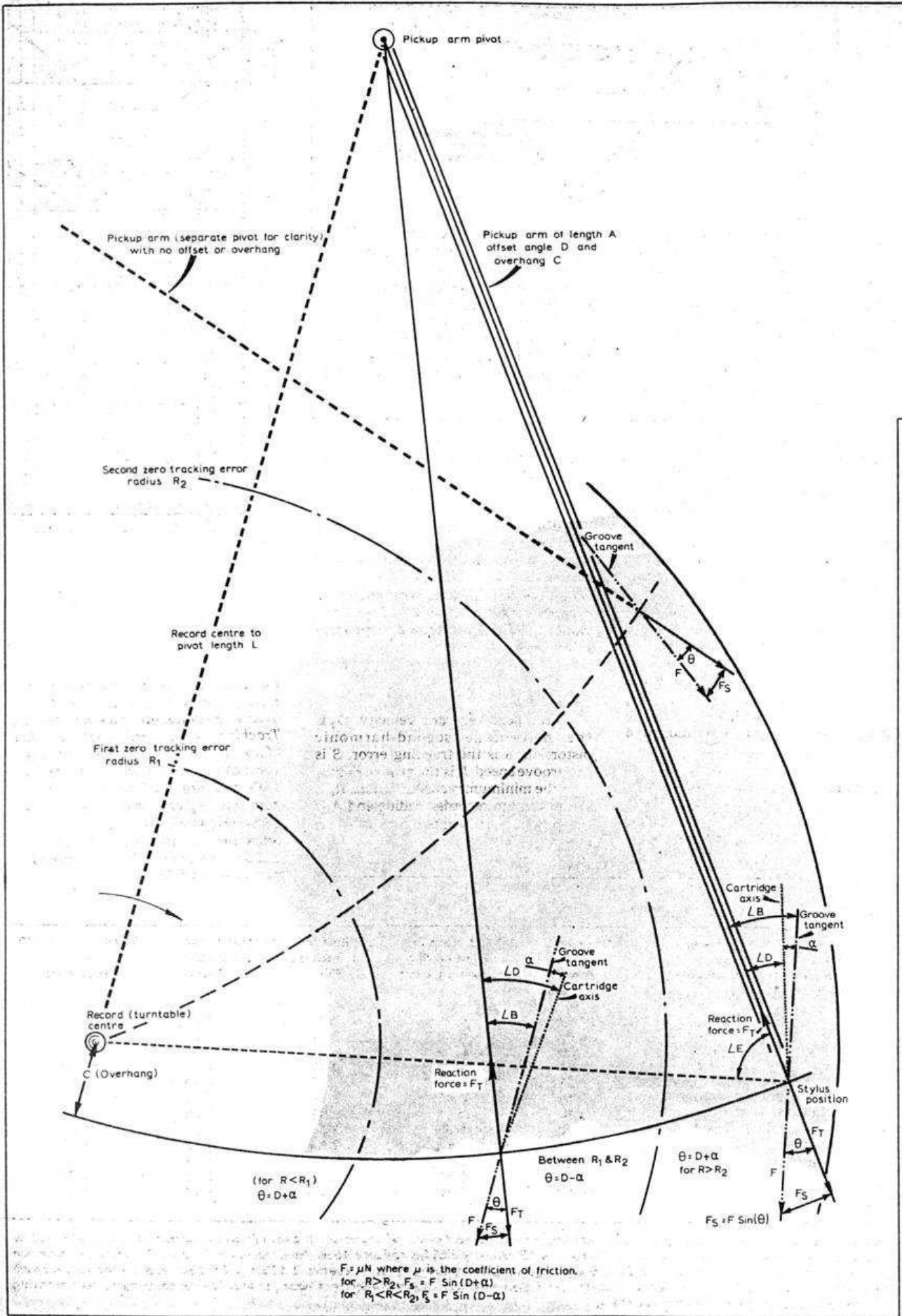

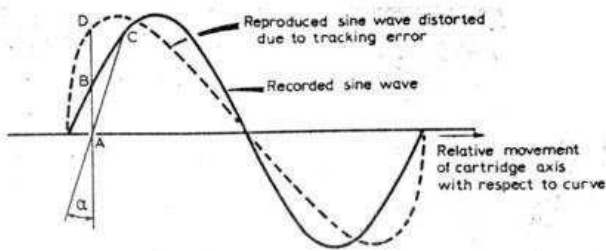

Fig. 1. (a) illustrates tracking error distortion. Due to the error, angle  $\alpha$ , the stylus moves from A to C, instead of B. Consequently, the reproduced signal amplitude is proportional to AD and not AB. The rest of the playback curve is produced in the same way. (b) Shows to scale, pickup arm positions relative to a record. The force triangles for skating force are shown for an

optimum design and also for a straight arm having no overhang or offset angle. In the latter case the tracking error is equal to  $\theta$ , which produces a considerable skating force. By applying the cosine law to the triangle at angle E, and remembering that  $\text{Cos}(E)$  is equal to  $\text{Sin}(B)$ , the tracking error equation, Equation 4, can be derived.

Equation 1:  $D_2 = 100V_0 \tan(\alpha)/S$

For recorded velocity equal to 10cm/s r.m.s., groove speed for  $33\frac{1}{3}$  rev/min, and correcting for a recording gain of 4dB/octave (by multiplying by  $10^{-4/20}$  for playback) the above equation reduces to:

$$D_2 = 100.85 \tan(\alpha)/R$$

$$= 100.85\alpha/R \text{ approx.}$$

Note that the term that requires minimizing is  $\alpha/R$ , not just  $\alpha$ . This means that more tracking error can be tolerated at a larger radii than at a smaller radii.

Equation 2: Offset angle (degrees)

$$D = R_a (1 + R_a/R_b) 57.3/AB$$

where  $B = 0.25 (1 + R_a/R_b)^2 + R_a/R_b$

Equation 3: Overhang

$$C = (R_a)^2/AB$$

Equation 4: Tracking error (see Fig. 1b)

$$\alpha = \sin^{-1}(R/2A + (2AC - C^2)/2AR) - D$$

To get the zero tracking error points for a combination of C and D, insert the values in Equation 4, equate to zero and solve for R.

**KEY**

$V_0$  is the peak recorded velocity,  $D_2$  is the percentage second-harmonic distortion,  $\alpha$  is the tracking error,  $S$  is the groove speed,  $R$  is the groove radius,  $R_a$  is the minimum recorded radius,  $R_b$  is the maximum recorded radius and  $A$  is the pickup arm length from pivot to stylus.

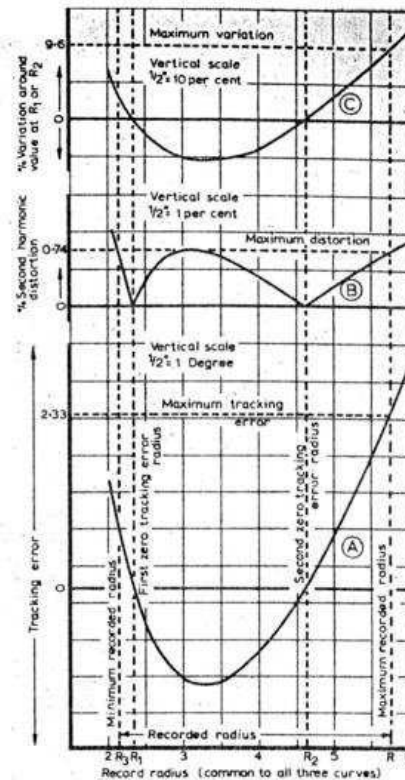
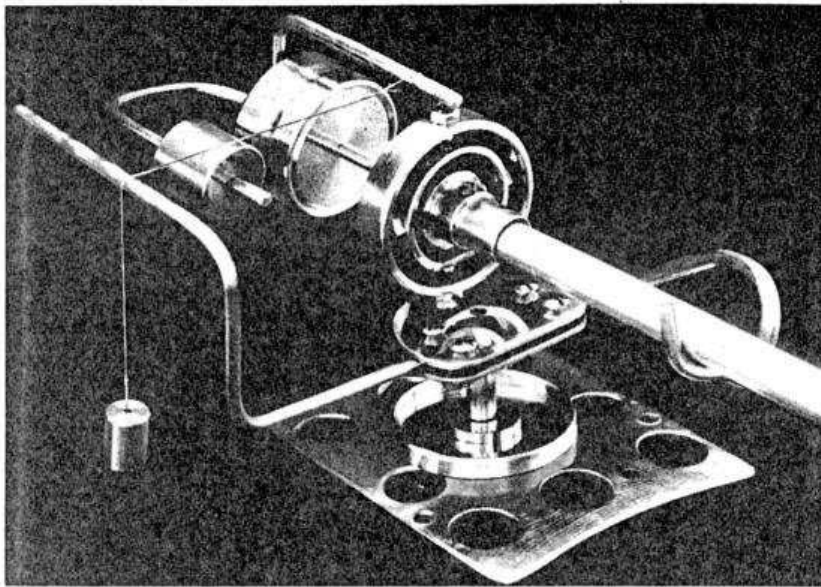

Fig. 2. Design curves for a 9in pickup having optimum offset angle and overhang values. (a) Tracking error. (b) Tracking error distortion. (c) Variation of skating force with reference to the value at the zero tracking error points. Main radii are: the first and second zero tracking error radii,  $R_1$  and  $R_2$  at 2.32in and 4.62in respectively; the minimum recorded radius,  $R_3$  at 2.125in; and the maximum recorded radius,  $R_4$ , at 5.75in.

Table

Pivot to stylus length (inches)	Optimum overhang (inches)	Optimum offset angle (degrees)	% 2nd harmonic distortion due to tracking error	Zero tracking error points in inches from record centre		Maximum tracking error (degrees)
				First	Second	
7.5	0.76	27.62	0.91	2.34	4.61	2.93
8.0	0.69	25.56	0.85	2.31	4.60	2.77
8.5	0.65	24.00	0.79	2.33	4.58	2.58
9.0	0.62	22.70	0.74	2.32	4.62	2.33
9.5	0.58	21.33	0.70	2.30	4.60	2.23
10.0	0.55	20.19	0.66	2.34	4.56	2.15
10.5	0.52	19.24	0.61	2.33	4.59	2.00
11.0	0.50	18.38	0.58	2.33	4.61	1.87
11.5	0.48	17.59	0.56	2.33	4.62	1.76
12.0	0.45	16.67	0.54	2.31	4.58	1.75
12.5	0.43	16.01	0.51	2.31	4.58	1.66
13.0	0.41	15.40	0.50	2.31	4.60	1.58

Notes. (1) Do not compare values above with other computations without checking the values of minimum and maximum recorded radii used by them. (2) The minimum recorded radius on a  $33\frac{1}{3}$  rev/min LP record is 2.625in and on a 45 rev/min record it is 2.125in. The maximum recorded radius on a  $33\frac{1}{3}$  rev/min LP record is 5.75in. Design figures given in table are for R between 2.125in and 5.75in, and the differential speed between 2.125in and 2.625in has been accounted for. (3) Column 4 is for a recorded velocity of 10cm/s r.m.s. The last column is for an arm having the optimum offset angle and optimum overhang.



Front-side view of mounting post and weighting arrangements for author's pickup arm.

than Bauer's results, but when setting up an arm, mounting errors can often give rise to more distortion and nullify the effect of these accurate calculations. Bauer's equations can therefore safely be used for as near optimum results as possible.

As can be seen from the table, a well designed and mounted 9in (effective length) pickup arm will give less than 1% harmonic distortion. These calculations are based on a worst case analysis — that is, for a completely monophonic lateral recording. In stereo (45-45) recordings, the corresponding distortion figures will be approximately divided by two. The introduction of 45-45 stereo brought the problem of vertical tracking error, and the resulting distortion, but helped in reducing distortion due to lateral tracking error. This indirect benefit comes because, in a 45-45 stereo recording, the total signal is the sum of a lateral and a vertical component (because the groove wall is at an angle of 45 degrees to the vertical) and the vertical component is not affected by lateral tracking error. As the vertical tracking angle is controllable there will be a net reduction in tracking error distortion. Vertical tracking error — the difference in angle between the vertical tracking angle of the cutting stylus and the playback stylus\* — has now been eliminated because the vertical recording and reproducing angle has now been standardized at 15 degrees. Until recently this was a big source of distortion. The 15-degree vertical tracking angle was recommended in 1961 by the Engineering Committee of the RIAA, but as late as 1965 vertical tracking angles of commercial pickups were measured<sup>11</sup> to be anything from 6 to 38 degrees.

\*This is a very simple, idealized definition and in practice problems are created by the springback action of the record material which has to be accounted for. See reference 10 for details.

Design curves for a 9in pickup arm having an optimum offset angle and an optimum overhang are shown in Fig. 2. Each curve is plotted with respect to the radius of the recorded groove. Curve A is a plot of the tracking error and Curve B shows the percentage of second-harmonic tracking error distortion. Curve C indicates the percentage variation of the skating force with respect to the value at the zero tracking error points.

Figure 3 illustrates how the overhang and the offset angle combine to reduce tracking error.

Fig. 3. Graphical illustration of how overhang and offset angle combine to reduce tracking error.

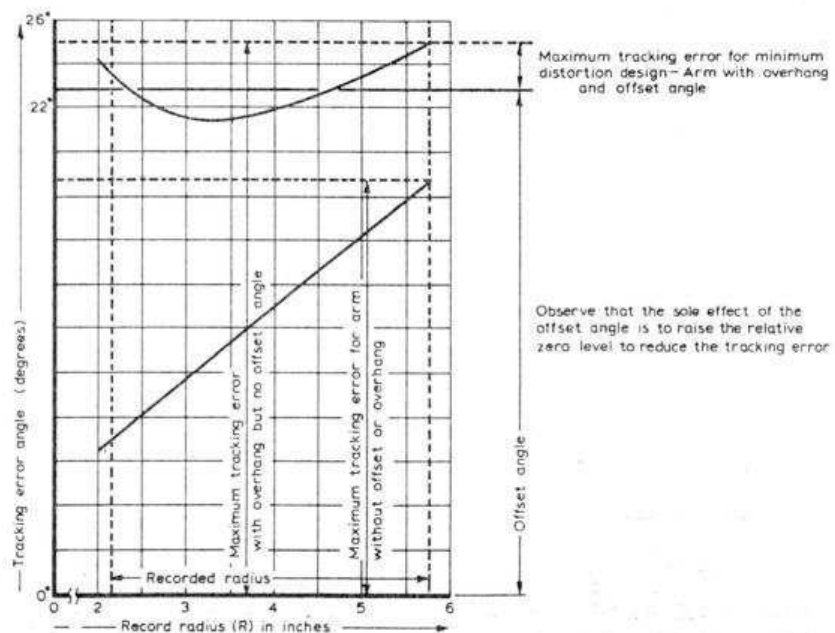

The next part of this article will include analyses of tracing error distortion, pick-up resonance, damping and skating force.

#### References

- 1 Glover, R.P., A Record Saving Pickup, *Electronics*, Vol. 10, p31, Feb. 1937.
- 2 Lebel, C. J., Quality in Disc Reproduction, *Electronics*, Vol. 10, p25, Oct. 1937.
- 3 Wilson P. and Webb, G. W., *Modern Gramophones and Electrical Reproducers*, Cassel & Co., London, 1929.
- 4 Wilson, P., Needle Track Alignment, *The Gramophone*, p129, Sept. 1924.
- 5 Olney, B., Phonograph Pickup Tracking Error vs Distortion and Record wear, *Electronics*, Vol. 10, p19, Nov. 1937.
- 6 Chamberlain, E. A., Correct Pickup Alignment, *Wireless World*, Vol. 26, p339, Mar. 1930.
- 7 Baerwald, H. G., Analytic Treatment of Tracking Error and Notes on Optimal Pickup Design, *J. Soc. Motion Picture Engrs.*, Vol. 37, p591, Dec. 1941.
- 8 Bauer, B. B., Tracking Angle in Phono Pickups, *Electronics*, Vol. 18, p110, Mar. 1945.
- 9 Stevenson, J. K., Pickup Arm Design, *Wireless World*, Vol. 72, p214-8 & 314-20, May & June 1966.
- 10 Bauer, B. B., The Vertical Tracking Angle Problem in Stereophonic Record Reproduction, *IEEE Trans. on Audio*, Vol. AU-11, p47, Mar.-Apr. 1963.
- 11 Redlich H. & Klemp, H. J., A New Method of Disc Reproduction for Reproduction with Reduced Distortion, *J. Audio Engg. Soc.*, Vol. 13, p111, Apr. 1965.

# Pickup arm design techniques — 2

Continuing the story of the pickup arm and the factors influencing its design

by Tejinder Singh Randhawa VU2TSR

In its account of the historical development of the pickup arm, Part 1 described how the problems of tracking error could be countered by clever design. This second part introduces additional factors to be considered in pickup arm design, beginning with tracing error distortion, and describes how they influenced the author in the design of his own pickup arm.

A serious form of distortion introduced by a finite-radius spherical stylus reproducing a cut record is tracing error distortion. This problem, illustrated in Fig. 4, was first recognized in 1932 by H. A. Frederick<sup>12</sup>, and the present name was given to the problem by M. J. D. Toro<sup>13</sup> in 1937.

The first rigorous analysis of tracing error distortion was done in 1938 by J. A. Pierce and F. V. Hunt<sup>14</sup>. The topic has since attracted considerable attention and further analyses have been carried out<sup>15,16,17</sup>. Tracing error distortion, which consists mainly of odd harmonics, and tracking error distortion, are the two major causes of distortion in record reproduction. Tracing error distortion, which is a problem relating to the transducer, is considered in this article on pickup arm design because it is instructive to compare the two.

Using the formulae for tracing error distortion with typical figures (a spherical stylus with a tip radii of 0.0006 inch), and using a relatively small arm, one finds that, after correcting for recording characteristics, the break frequency between tracking error distortion and tracing error distortion occurs at about 2,000Hz. In other words, for the recorded signal below 2,000Hz

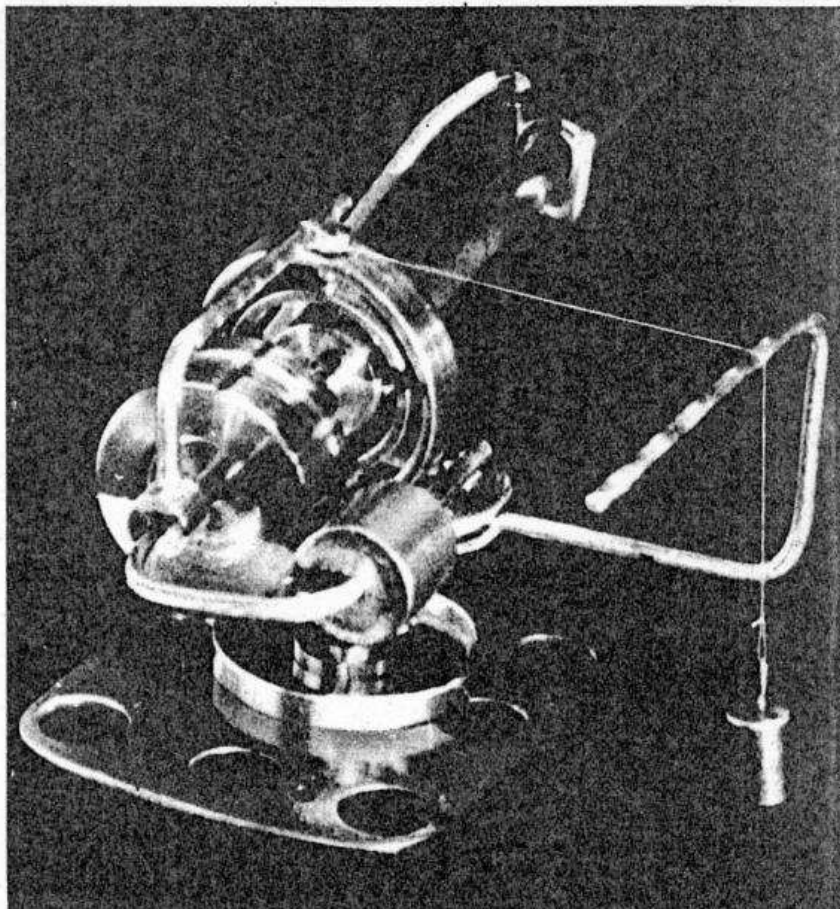

Rear view of mounting post and weighting arrangements for author's pickup arm.

Fig. 4. Graphical representation of how a recorded pure sinewave becomes a distorted sinewave when played back by the stylus.

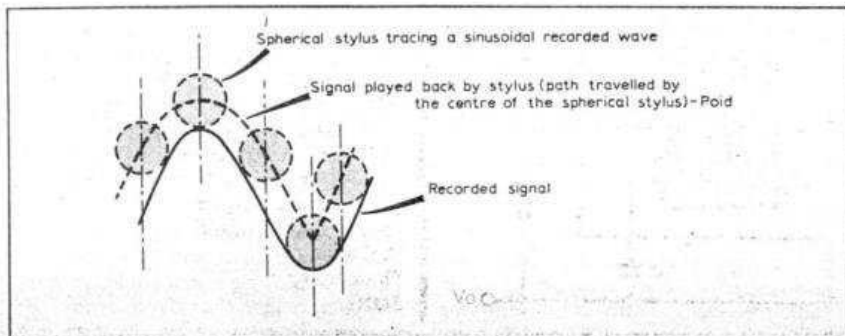

tracking error dominates, while above this figure, tracing error distortion takes over. However, with the coming of elliptical styli, the break frequency is shifted to between about 4,000 and 6,000Hz because the effective stylus radius (the portion of the stylus that traces the groove modulations) is reduced to about one-half or one-third that of spherical styli, and the tracing error distortion is proportional to the square of the effective radius and the frequency.

Since tracing error consists mainly of odd harmonics, the harmonic distortion components will lie above 12,000Hz. However, in practice the actual tracing error distortion produced is less than the theoretically-calculated figure because of the deformation of the groove. To further reduce tracing error distortion, papers have been published<sup>17,18,19</sup> describing equipment that has been

designed to compensate for tracing error in the recording process itself. One method that was suggested (and used briefly for vertical recordings, in the earlier days) was to reproduce the distorted traced signal and re-record it in reversed phase. The main disadvantage with this method is that it would require strict standardization of reproducing styli on all domestic cartridges.

If one considers that tracing error distortion is comparable to tracking error distortion, and that a properly mounted 9in (effective length) arm will give second-harmonic tracking-error distortion figures of less than 1% (see table), it might seem pointless to reduce tracking error distortion by articulating arms, pivoted heads and associated gadgetry, which only increase the inertia of the pickup arm and its effective mass. This is undesirable, as will be explained later. An earlier device, the Burne Jones arm, which had a pivoted head, was claimed to have a maximum tracking error of 1 degree. The Ortho-Vox arm corrected for tracking error by varying the effective length of the arm and the overhang as the arm moved across the record. The resulting reduction in tracking error was claimed to be equivalent to extending the arm length to 8 feet. Perhaps the ultimate, accurate application of the pivoted head method has been achieved by the Garrard Zero 100 arm. This arm has a maximum tracking error of 0.022 degrees at the record radius of 3.25in. For a detailed computer analysis of the linkage of this arm, see reference 20.

For minimum tracking error distortion, it is important to set the offset angle and overhang accurately. Different cartridges have varying positions for the stylus relative to the mounting screws. To overcome this problem, in some pickup arms, the cartridge can be moved within the shell to place the stylus at the correct position, while in others the entire pickup arm can be moved to or away from the turntable centre to vary the overhang. The former method has its advantages because, when the stylus position changes considerably, both the overhang and the effective stylus-pivot length of the arm change. Consequently, a new effective length would require a recalculation of the offset angle, overhang and the zero tracking error points. Now, as seen from the table, a change in the effective length of the arm does not significantly change the zero tracking error points. However, this assumes that the offset angle is the optimum one for the length. In the above case the offset angle is fixed and will differ from the optimum. Fortunately, it will be corrected automatically to some extent because an increase or decrease in the effective length will correspondingly decrease or increase the offset angle. This can be verified from the geometry of a pickup arm. Also, from the formula it can be seen that, as the arm length increases the offset angle required decreases, and

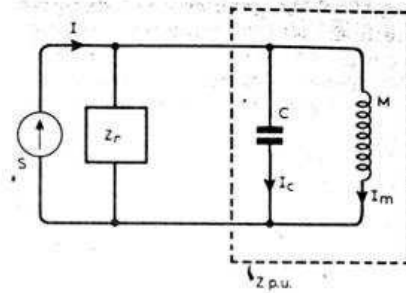

Since  $Z_r \gg Z_{p.u.}$ ,  $S$  acts as a constant current source and  $Z_r$  can be neglected from the analysis, then for the parallel resonant frequency  $(f_0) = \frac{1}{2\pi\sqrt{MC}}$

**Fig. 5.** Equivalent circuit of a pickup arm and cartridge.  $S$  is the current (velocity) source,  $C$  is the stylus compliance,  $I$  is the current (modulation velocity),  $I_c$  represents the velocity of the stylus tip relative to the arm (transducer velocity), and  $I_m$  represents the arm velocity.  $Z_r$  is the mechanical impedance of the turntable as seen by the stylus and is a function of the compliance and resistance of the record material and supporting means.  $M$  is the mass of the arm referred to the stylus point ( $M = I_h/R^2$ ) where  $I_h$  is the total inertia of the arm about the pivot and  $R$  is the pivot-to-stylus length.

vice-versa. On the other hand, the latter method has the advantage that the shell can be made smaller and lighter.

An accurate iterative procedure for setting the arm optimally has been suggested by Stevenson. This procedure requires the use of an alignment protractor. At the first zero tracking error radius  $R_1$ , Fig. 1(b), the overhang should be adjusted until the tracking error is zero (with the offset angle set to approximately the optimum value). At  $R_2$ , the second zero tracking error point, one should observe whether the tracking error is positive or negative. A positive tracking error will be obtained at radii greater than  $R_2$ . If it is positive, it indicates that both the offset angle and the overhang are less than the optimum value and should be increased slightly. If the tracking error at  $R_2$  is negative, it indicates that the offset angle and the overhang are larger than the optimum value and should be decreased slightly. The above steps should be repeated until minimum tracking error at  $R_1$  and  $R_2$  is obtained.

#### Pickup arm-cartridge resonance

The electrical equivalent circuit of the arm and cartridge combination is illustrated in Fig. 5 and, as can be seen, the stylus compliance and effective mass of the pickup arm form a parallel resonant circuit. This will create problems if the resonance frequency coincides with an audio frequency or any other annoying frequency. For various  $M$  and  $C$  com-

binations, the range of  $f_0$  lies in the lower end of the audio spectrum – below about 40Hz. There was a time when  $f_0$  used to lie at about 60Hz because of the extremely low compliance of the styli of the available cartridges, and attempts were made to lower it. Nowadays, it is the opposite; with high compliance cartridges available,  $f_0$  tends to go down to below 10Hz and manufacturers are desperately attempting to lower the value of  $M$  for their arms, making small improvements wherever possible, even to the extent of doing away with headshell collar nuts. This is justified.

To have a low value of  $M$ , a light gauge aluminium tube should be used in a way that employs the shortest length of the tube (as in Fig. 6(b)). Why bends are still used despite this disadvantage can be appreciated only when one tries to design a turntable oneself. With the bend, the arm in Fig. 6(a) will have a smaller angular motion from the rest position (parallel to the side edge of the record player unit) to the end of the record than the straight tube arm. Further, a heavier counterweight near the pivot, rather than a lighter one at a correspondingly greater distance, decreases  $M$ . All this trouble to decrease  $M$  and raise  $f_0$  has to be taken because the region 0 to 10Hz can be full of troublesome frequencies due to eccentric centre holes in records, warps, ripples, turntable platter excitation, and so on. Even though the inherent response of the cartridge at these very low frequencies might be extremely small, resonance effectively magnifies the response, and if these frequency signals reach the speaker, a Doppler effect will result. Given a choice  $M$  should be smaller in the vertical direction than in the horizontal direction to raise the vertical  $f_0$  component, since rumble is greater in the vertical direction than in the lateral direction. Also, less vertical inertia helps the arm in coping with record warps.

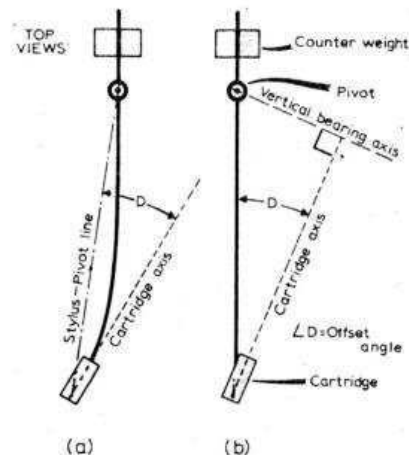

**Fig. 6.** Two methods of setting a cartridge at an angle to the pickup arm. Employing a short tube, as in (b), helps to reduce the effective mass of the arm.

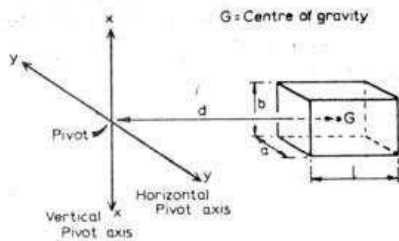

Inertia about vertical pivot =  $I_{xx} = \frac{1}{12} M(b^2 + l^2) + Md^2$

Inertia about horizontal pivot =  $I_{yy} = \frac{1}{12} M(a^2 + l^2) + Md^2$

Fig. 7. Optimum design of a rectangular parallelepiped counterweight ( $M$  is the mass of the counterweight).

Fig. 7 gives the optimum design for a rectangular parallelepiped counterweight and the inertia formulae relating to it. Unfortunately, some designers use counterweights of this kind but with  $b$  much greater than  $a$ . As can be seen from the equations, this results in a condition where the vertical inertia is greater than the horizontal inertia. This is undesirable because it results in a lower vertical resonance frequency (with respect to horizontal resonance frequency) and this decreases the arm's ability to track warped records. In fact, for a lower vertical inertia (with respect to horizontal inertia) both  $b$  and  $l$  should be made smaller, however unconventional the counterweight might look.

### Damping

The pickup-arm cartridge resonance can be damped by mechanical resistance damping in the stylus and the pivot, or by dynamic damping. Figure 8(a) shows the equivalent circuit for the first method. This method of damping the pickup arm-cartridge resonance was dropped when it was pointed out in 1951<sup>21</sup> by W. S. Bachman that large tracking weights will be required if  $R$  is selected for effective damping. For effective damping  $R = \sqrt{4M/C} = 2000\Omega$  assuming  $M = 16\text{gms}$  ( $H$ ) and  $C = 16\mu\text{F}$ . Now  $F = RV/\sqrt{2} = 20,000$  dynes, approximately 20gms (where  $V$  is the peak recorded velocity) for a recorded velocity of 10cm/s r.m.s.

Figure 8(b) shows the equivalent

circuit of the popular pivot damping method, which Bachman recommended. An efficient way of applying this method of damping was to have a pivot in the form of a hemisphere and a complementary cup or mandrel and sleeve arrangement: The distance between the two was variable, and the volume in between was filled with a viscous fluid. In this way, knowing the dimensions of the arrangement and the fluid viscosity, a value of  $R$  could be calculated. (For details of the 'Gray', viscous damped arms 108C and 212, see reference 22.) This method was suitable for the high-tracking-weight, low-compliance cartridges of 20 years ago, but not for the low-tracking-weight, high-compliance cartridges of today. Indeed, the arms were damped so much that manufacturers used to boast that, with their viscous damped arm, a record could not be damaged due to the arm being accidentally dropped over the record, because it would simply fall down very gently.

As can be seen from the equivalent circuit, at low frequencies, the insertion of a resistance in the  $M$  branch tends to reduce the current in that branch and divert more to the  $C$  branch. Physically, this means that the low frequency response of the cartridge would be increased. This may be a disadvantage if the cartridge already has a good low frequency response characteristic because it would increase its response in the danger zone 0 to 15Hz. It is worth mentioning that in the older designs  $R$  was calculated and applied meticulously. These days we sometimes come across the deplorable quack tendency of applying a dash of oil or a spot of grease to effectively damp all resonances.

In the third method, dynamic damping, the arm mass is divided into two separate parts and joined through a visco-elastic coupling, as shown in Fig. 9. Fig. 8(c) shows the equivalent circuit for this method. B. Bauer<sup>23</sup> has experimentally determined that, for this method to be effective, the ratio of the mass associated with the rest of the arm ( $M_2$ ), should be at the most 3:7 (ideally it should be 0:10 which of course is impossible). To obtain this, the cartridge and shell portion of the arm should be as light as possible and the visco-elastic coupling should be immediately behind the shell. It is unfortunate that manufacturers place the

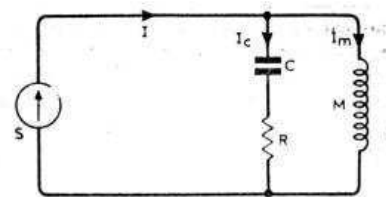

$R$  = Resistance introduced in stylus mounting

(a)

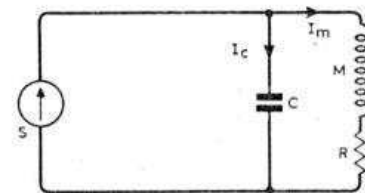

Below the recorded audio frequencies  $S$  represents the slow motion of the arm from the outer to the inner part of the record—due to the stylus following the groove

$R$  = Resistance introduced in arm mounting

(b)

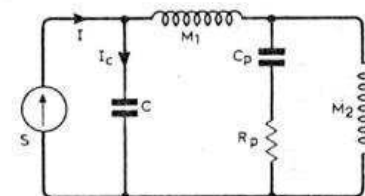

$C_p$  and  $R_p$  are the Compliance and Resistance, respectively, of the coupling

(c)

Fig. 8. Equivalent electrical circuits for (a) stylus resistance damping, (b) mechanical resistance damping in arm pivot, and (c) dynamic damping.

coupling way behind the shell, just in front of the counterweight, as this makes the damping less effective.

All the above methods work optimally, only within certain restrictions. Resonance problems were mainly associated with audio frequencies on the older units, but today rumble pickup, which is greater in the vertical direction, and warps and ripples on the record, are the main cause. Keeping these points in mind the author tried to use mechanical resistance damping in the vertical pivot only, keeping the horizontal pivot resistance free so that it did not oppose the slow motion of the arm from the outer to the inner portion of the record. In this design, the resistance applied to the vertical pivot was not of the constant-resistance fluid type. Instead, a static value of resistance was applied when the arm was stationary in the vertical plane, but when a warp moved the arm upward a dynamic value came into effect (which

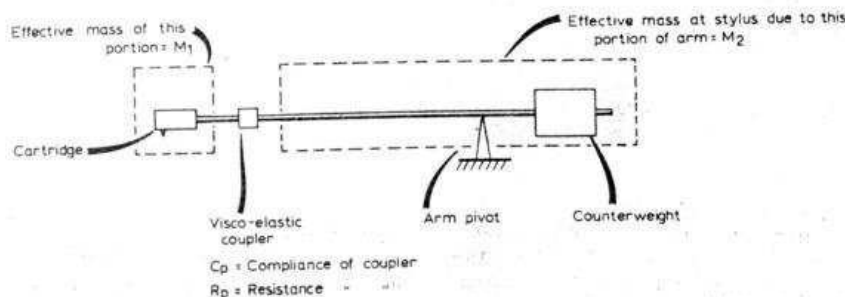

Fig. 9. Physical arrangement of dynamic damping parameters.

was less than the static value), which made it easier for the arm to cope with the warp. However, the author dropped this method because even the smaller dynamic value resulted in an audible wow when a high compliance cartridge went over a warp.

Another feature that the author had in his older arm was adjustable inertia. It is perfectly alright to design an arm with a minimum  $M$  but sometimes the  $M$  and  $C$  values combine to place  $f_0$  where it coincides with an annoying frequency (assuming inefficient damping). Since  $M$  cannot be decreased further, the only way out would be to change  $C$  — the cartridge. However, when  $M$  can be increased it can help in decreasing the pickup of the annoying frequency, as explained in Fig. 10(a). To vary the inertia while keeping the tracking weight fixed, the author made a counterweight in three parts such that  $M$  could be increased by moving the outer parts of the counterweight outwards, as shown in Fig. 10(b). He did not use this counterweight in his latest arm because it required a heavy counterweight as near to the pivot as possible. Nonetheless, the author still strongly advocates the use of adjustable inertia since, if one is troubled by the pickup of a troublesome frequency,  $M$  can be increased by adding external weights to the arm to see if it helps.

### Skating force

Skating force, or sidethrust force, is perhaps the most debated topic in pickup arm design. Points raised by audio enthusiasts include, whether skating compensation is necessary, what kind of compensation is the best and the best way to calibrate it, whether it stays constant across the record radius or increases or decreases. It is something like the Yagi versus Quad controversy among radio amateurs. Different arguments, with certain qualifications, can be put forward both for and against the necessity of skating compensation.

At the outset, the author would like to stress that the total sidethrust force is not that component of the tangential frictional force that is directed to the

record centre, as is popularly but erroneously thought. The true skating force is that component of the tangential frictional force which acts at right angles to the pivot-stylus line. The former is less than the latter. This restatement is necessary because, often in articles the formula for the former is derived and it is said that it is this force that the antiskating mechanism has to counter. The formula for skating force and the force diagrams are given in Fig. 1(b). A look at this figure also points out another fallacy that exists regarding skating force. It is said that the skating force arises because of the offset angle and the overhang. This is wrong. Even if there were no offset angle and overhang in an arm, skating force would exist because of the large tracking error.

The stylus position for a straight arm passing through the centre of the record is also shown in Fig. 1(b). The tracking error of such an arm at the start of a 12 inch record will be  $18.6^\circ$  for an effective arm length of 9in. (This is obtained by putting  $C$  and  $D$  equal to zero in the tracking error equation — Equation 4). The skating force for this case would therefore be equal to  $F\sin(18.6)$  which is slightly less than the skating force for an arm of the same effective length having the optimum offset angle and overhang ( $F\sin(25)$ ). In fact, offset angle and overhang help in reducing drastically the variation of the skating

force across the record, since, in the former straight-arm, zero overhang case, the skating force at the minimum recorded radius would equal  $F\sin(7)$  — an enormous variation compared to the value at the start of the record. The variation in skating force for a 9in optimum design is shown in Fig. 2(c), which follows from Fig. 1(b). It is maximum at the start of play, decreases and then increases.

For a blank disc, providing the disc speed is constant, the skating force should remain constant, because it depends on the dynamic friction coefficient. In practice, when playing a modulated disc, the skating force is increased and made slightly dependent on the groove speed because of the modulations. This dependence on record speed is insignificant and so different calibrations are not necessary for  $33\frac{1}{3}$  rev/min and 45 rev/min records. Elliptical styli require negligibly greater skating compensation than spherical styli. Different arm lengths have different offset values and tracking error angles, and therefore the skating force, will vary, its value being smaller for longer arms. In other words, there is no fixed value for it.

Experiments have proved that skating force does give rise to considerable distortion<sup>24</sup> and so it is desirable to counter it. Various bias adjusters or sidethrust compensators may be used to counter this force. These include magnetic repulsion, levers and the 'weight on a nylon thread' method, which was suggested by John Crabbe in 1960 and till today remains a popular, simple method to oppose the skating tendency. One cartridge manufacturer even claims that a brush attached permanently to the front of the cartridge (primarily to clean the record) is sufficient to counter the skating force.

### Lateral balancing

The most misused and misunderstood feature on modern pickup arms is the lateral (or angular) balance adjustment control. It comforts the user, assuring him that all forces are balanced, leaving the cartridge to turn angles. The basic reason why the lateral force arises when the mounting is tilted is because the entire arm turns angularly around the arm tube axis. This is illustrated in Fig. 11(a). Due to the bend in the arm the centre of gravity (c.g.) of the arm section in front of the mountings will lie somewhere in the triangle ABC in the horizontal plane of motion of the arm. If the mounting is vertical, then at the second position of the arm the plane of the triangle ABC will remain horizontal. Now, suppose that the mounting is tilted forward, as in Fig. 11(b). Observe that the arm is still perfectly horizontal. (The following example is valid only for a gymbal mounted as shown in Fig. 11(c). That is, one with a vertical bearing in the inner ring, a knife edge mounting for vertical motion, and a

**Fig. 10(a).** Diagram shows that an increase in the effective mass of the pickup arm helps to reduce the pickup of an annoying frequency which coincides with the resonance frequency. When the arm inertia is increased the effective mass referred to the stylus tip increases and the resonant peak (assuming insufficient damping) shifts to the left.

**Fig. 10(b).** Physical implementation of Fig. 10(a). By moving the outer parts of the three-part counterweight outwards, the inertia will be increased without affecting the tracking weight.

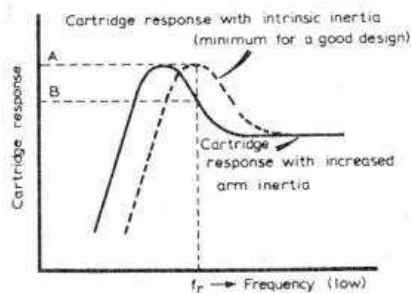

$f_r$  = Rumble frequency  
 A = Rumble pickup for minimum inertia case  
 B = Rumble pickup when  $M$  is increased — resonance frequency decreases

(a)

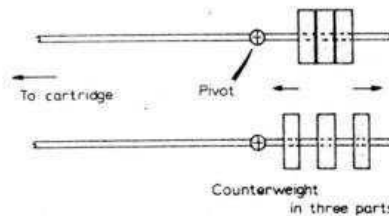

(b)



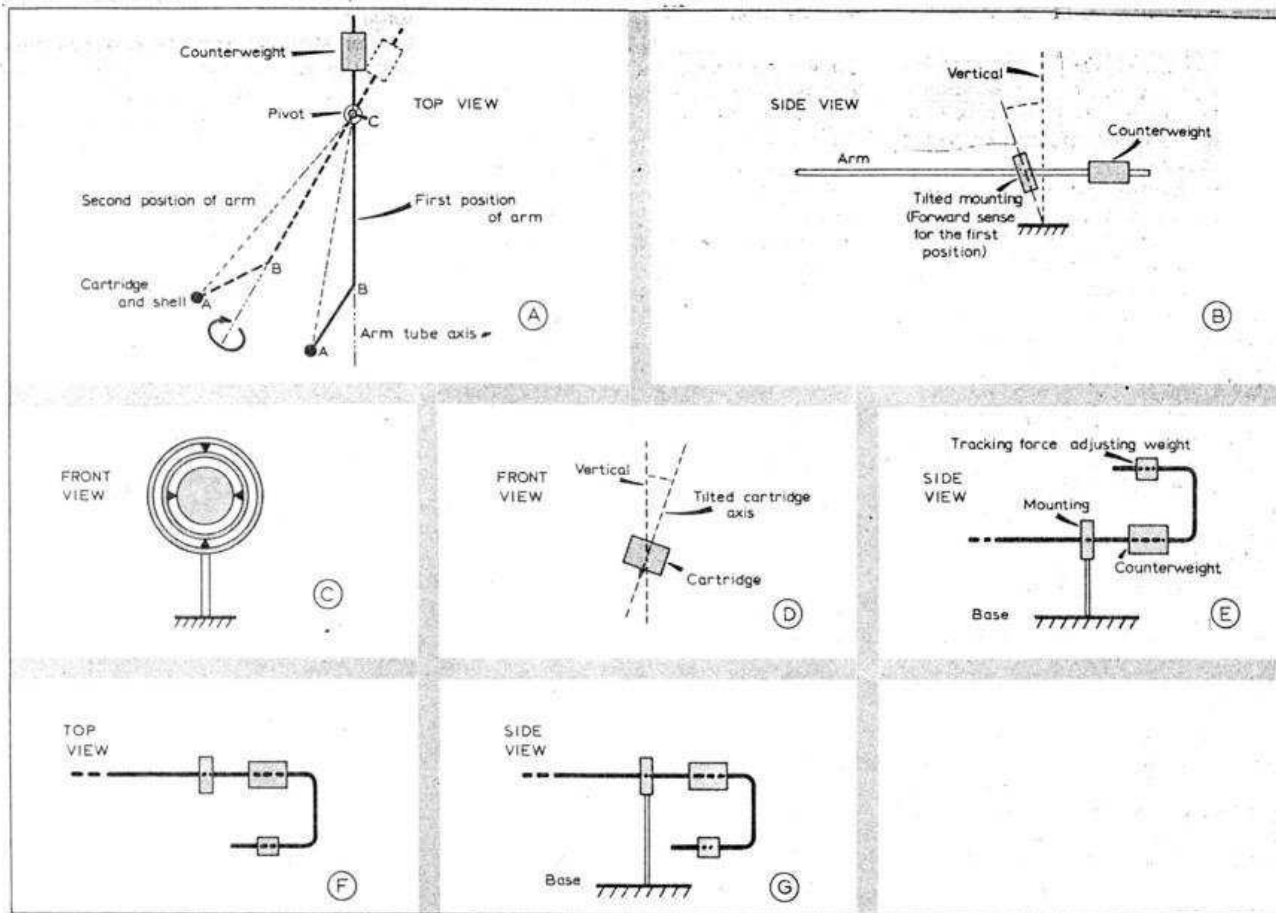

bearing for horizontal motion). In this case, when the arm moves to the second arm position, the arm and hence the triangle ABC, will tend to turn around the arm axis in the direction indicated. As this would entail the raising of the centre of gravity of ABC, such a movement will be opposed. In simple words, an anti-clockwise torque will result. In the conventional lateral balancing arrangement, a weight (which can be the tracking force adjustment weight itself) is placed in the lateral plane on the side opposite to the bend (Fig. 11(f)). Then, for the above case, an anti-clockwise movement would tend to raise the weight and give rise to a clockwise torque. The distance of this weight from the arm in the lateral plane is adjusted so that the two torques are equally opposed. An eccentric counterweight is sometimes used for this purpose.

This method successfully counters the lateral force but the arm mounting is still not vertical. Consequently, when the arm moves to the second position, the cartridge axis will not be vertical but will be at an angle to the vertical (Fig. 11(d)). Clearly, this is to be avoided. In effect, the lateral balancing control is a solution to one of the outcomes of the problem and not a solution to the basic problem itself. The author believes that a few extra minutes spent while mounting the arm, to ensure that the mounting is vertical, would be a better solu-

**Fig. 11. Tilted mountings.** *If a mounting, of the gymbal type as in 'c' or the 'knife-edge and bearing' type, is tilted forward as in 'b', the arm will tend to turn about the tube axis. In a bent-arm construction, this results in a torque in the anticlockwise direction because the c.g. of the triangle ABC will tend to occupy the lowest possible position. (Observe that the arm is horizontal in 'b'.) Tendency of arm to rotate as in 'a' results in axis of cartridge tilting as in 'd'. Anticlockwise force can be countered using tracking-force adjusting weight in horizontal plane of the arm on side of counterweight opposite the offset, as in 'f'. 'e' illustrates an unstable arrangement for the weight, and 'g' illustrates the stable arrangement.*

tion and would be time well spent. In the author's latest arm design, lateral force adjustment is possible because the U-shaped rod carrying the counterweight and the tracking-force adjusting weight can be rotated around the arm tube axis enabling the perpendicular distance (in the horizontal plane) between the tracking weight and the axis to be varied. This can be used to apply a variable lateral force to both sides of the arm. However, it is better to ensure that the gymbal is mounted absolutely vertical in the first place. In any case, the straight tube design obviates the need

for lateral balancing since the so called lateral force for tilts will be negligible. It might seem odd, therefore, that the author has chosen to mount the tracking force weight in the horizontal plane of the arm and not the vertical plane, thereby deliberately off-balancing the arm laterally, in the conventional sense. The reason is that the term lateral balance is a misnomer and a more appropriate term would be 'angular balance.' For example, consider Fig. 11(e), where all the mass elements of the pickup arm lie in the vertical plane of motion of the arm. It might be construed that, in this case, the arm would be inherently laterally balanced. This is not so, and a little thinking (and the reader is urged to experiment himself) shows that if the mounting is tilted forward, a slight displacement of the arm in the clockwise sense will result in a clockwise torque. A small displacement of the arm in the anticlockwise direction will result in a torque in the anti-clockwise direction (that is, relative to the centre position).

The tracking force weight can be placed in three positions. It can be placed in the horizontal plane of the arm on the side of the counterweight (Fig. 11(f)), in the vertical plane of the arm above the counterweight (Fig. 11(e)), or below the counterweight (Fig. 11(g)). A little thought (and experimentation) will show that Fig. 11(f) corresponds to neutral equilibrium, Fig. 11(e) corres-

ponds to unstable equilibrium and Fig. 11(g) corresponds to stable equilibrium. Physically, it means that in the last two cases, for a fixed setting of the tracking force weight, the tracking force at the stylus will vary for different levels of the arm (for record changer arms). In general, to measure the vertical friction and stiction of the arm at the stylus position, the arm should be balanced and a small weight placed on the shell. The value of this weight, which is sufficient to move the arm appreciably, gives the required figure. Clearly, there is going to be a difference, for the 'stable' and the 'unstable' position (the value for the former will be more than the latter). So, to appreciate the friction figures of an arm, a knowledge of the equilibrium condition of the arm will be in order.

### Pickup arm length

After discussing the essential features of pickup arms, it is now possible to decide the optimum length of a pickup arm. The various points that are affected by pickup arm length are: tracking error distortion, record wear due to tracking error, elliptical-stylii lag effect due to tracking error, effective mass of the arm, the inertia of the arm, skating force, and friction and stiction measured at the stylus point. A 12in arm gives less tracking error distortion than a 9in arm (see table) but a properly mounted 9in arm gives less than 1% harmonic distortion. Since tracing error distortion is comparable to tracking error distortion, it would seem pointless to increase the length beyond 9in to further decrease tracking error distortion. Since a 12in arm has less maximum tracking error than a 9in arm (0.58 degrees less) it might be construed that it will wear records less. However, with the high compliance cartridges available nowadays, this will be insignificant.

It is said that elliptical stylii can reduce tracing distortion at the expense of increasing error by causing a lag effect (reproduction delay) between the two channels of a stereo record<sup>9</sup>. This arises because, due to tracking error, the elliptical stylus does not trace the groove exactly as it was recorded since one point of contact will be slightly delayed or advanced relative to the other. Calculations show that a 12in arm does not improve matters considerably over a 9in arm, in this respect. In any case, it should be noted that tracing error is itself a form of delay (or lag and lead) distortion. This is illustrated in Fig. 4. Calculations show that the effective mass  $M$  for a 9in arm is smaller than for a 12in arm. As stated earlier, a smaller value of  $M$  is desirable. To be able to play a warped record properly, the term  $I_H\omega$  (angular momentum) has to be a minimum for a particular arm. For a given warp amplitude, the angular velocity imparted to the 12in arm will be 9/12th of the angular velocity imparted to the 9in arm, but, because there is also

an increase in the inertia, the beneficial effect of using the longer arm is cancelled. Since a smaller offset angle is required for a 12in arm than for a 9in arm, the former will have a smaller skating force. Compensation will still be required for the longer arm and so this advantage does not really help matters, unless the user is averse to using sidethrust compensation. For given friction and stiction figures for a mounting, a smaller force will be required to move the arm at the stylus position 12 inches from the pivot, than at 9 inches from the pivot. A good mounting has a low enough inherent friction and stiction, so this is of negligible advantage in favour of the longer arm.

From the above points it is evident that a smaller 9in arm has a clear advantage over a longer 12in arm. Not surprisingly, the trend these days is towards smaller arms and some manufacturers have even stopped production of their longer models. □

### References

- 12 Frederick, H. A., Vertical Sound Records, *J. Soc. Motion Picture Engrs.*, Vol. 18, p141, Feb. 1932.
- 13 Toro, M. J. D., Distortion in Sound Reproduction, *J. Soc. Motion Picture Engrs.*, Vol. 29, p493, 1937.
- 14 Pierce J. A. & Hunt, F. V., Distortion in Sound Reproduction from Phonograph Records, *J. Soc. Motion Picture Engrs.*, Vol. 31, p157, Aug. 1938.
- 15 Lewis W. D. & Hunt, F. V., A Theory of Tracing Distortion in Sound Reproduction from Phono Records, *J. Acoustic Soc. Amer.*, Vol. 12, p348, Jan. 1941.
- 16 Roys, H. E., Analysis by the Two Frequency Intermodulation Method of Tracing Distortion Encountered in Phonograph Reproduction, *R.C.A. Review*, Vol. 10, p254, June 1949. See also Sept. 1953.
- 17 Corrington, M. S., Tracing Distortion in Phonograph Records, *R.C.A. Review*, Vol. 10, p241, June 1949.
- 18 Fox E. C. & Woodward, J. G., Tracing Distortion - It's Cause and Correction in Stereodisk Recording Systems, *J. Audio Engg. Soc.*, Vol. 11, p294, Oct. 1963.
- 19 Washizawa, S. et. al., Development of Skew Sampling Compensator for Tracing Error, *J. Audio Engg. Soc.*, Vol. 21, p630, Oct. 1973.
- 20 Freudenstein F. & Soylemez, E., Kinematic Design of Tone Arm Articulation for Minimum Tracking Error in Automatic Turntables, *Mechanism & Machine Theory*, Vol. 8, p517, Winter 1973.
- 21 Bachman, W. S., The Application of Damping to Phonograph Reproduction Arms, *Proc. I.R.E.*, Vol. 40, p133, Feb. 1952.
- 22 Snow, C. A., A New Viscous Damped Tone Arm Development, *J. Audio Engg. Soc.*, Vol. 6, No. 3, p197, July 1958.
- 23 Bauer, B. B., Damping of Pickup Arms, *J. Audio Engg. Soc.*, Vol. 11, p207, July 1963.
- 24 Woodward J. G. & Werner, R. E., High Frequency Intermodulation Testing of Stereo Phonograph Records, Vol. 15, p130, April 1967.